

NTJD3158C

Power MOSFET

20 V, +0.63/-0.82 A,
SC-88 Complementary, ESD Protected

Features

- Complementary N- and P-Channel MOSFET
- Small Size Dual SC-88 Package
- Reduced Gate Charge to Improve Switching Response
- Independently Connected Devices to Provide Design Flexibility
- This is a Pb-Free Device

Applications

- DC-DC Conversion Circuits
- Load/Power Switching with Level Shift

MAXIMUM RATINGS (T_J = 25°C unless otherwise noted)

Parameter		Symbol	Value	Unit	
Drain-to-Source Voltage		V _{DSS}	20	V	
Gate-to-Source Voltage		V _{GS}	±12	V	
N-Channel Continuous Drain Current (Note 1)	Steady State	T _A = 25°C	I _D	0.63	A
		T _A = 85°C		0.46	
	t ≤ 5 s	T _A = 25°C		0.72	
P-Channel Continuous Drain Current (Note 1)	Steady State	T _A = 25°C	I _D	-0.82	A
		T _A = 85°C		-0.59	
	t ≤ 5 s	T _A = 25°C		-0.93	
Power Dissipation (Note 1)	Steady State	T _A = 25°C	P _D	0.27	W
	t ≤ 5 s			0.35	
Pulsed Drain Current	N-Ch	tp = 10 μs	I _{DM}	1.3	A
	P-Ch			-1.6	
Operating Junction and Storage Temperature		T _J , T _{stg}	-55 to 150	°C	
Source Current (Body Diode)		I _S	0.46	A	
Lead Temperature for Soldering Purposes (1/8" from case for 10 s)		T _L	260	°C	

THERMAL RESISTANCE RATINGS

Parameter	Symbol	Max	Unit
Junction-to-Ambient – Steady State (Note 1)	R _{θJA}	460	°C/W
Junction-to-Ambient – t ≤ 5 s (Note 1)	R _{θJA}	357	
Junction-to-Lead (Drain) – Steady State (Note 1)	R _{θJL}	226	

Stresses exceeding Maximum Ratings may damage the device. Maximum Ratings are stress ratings only. Functional operation above the Recommended Operating Conditions is not implied. Extended exposure to stresses above the Recommended Operating Conditions may affect device reliability.

1. Surface mounted on FR4 board using 1 in sq pad size (Cu area = 1.127 in sq [1 oz] including traces).



ON Semiconductor®

<http://onsemi.com>

V _{(BR)DSS}	R _{DS(on)} Max	I _D Max
N-Ch 20 V	375 mΩ @ 4.5 V	0.63 A
	445 mΩ @ 2.5 V	
P-Ch -20 V	300 mΩ @ -4.5 V	-0.82 A
	500 mΩ @ -2.5 V	

SC-88 (SOT-363) (6-Leads)

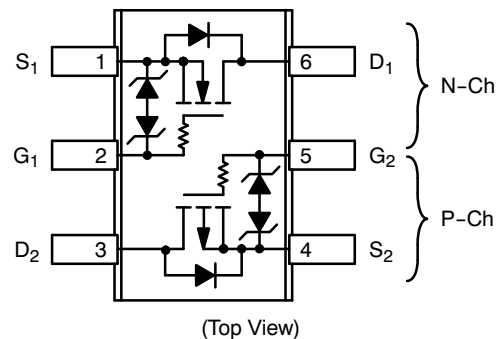

MARKING DIAGRAM & PIN ASSIGNMENT



SC-88 (SOT-363)
CASE 419B
STYLE 26

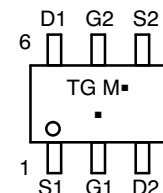

- TG = Specific Device Code
- M = Date Code
- = Pb-Free Package

(Note: Microdot may be in either location)

ORDERING INFORMATION

Device	Package	Shipping†
NTJD3158CT1G	SC-88 (Pb-Free)	3000/Tape & Reel
NTJD3158CT4G	SC-88 (Pb-Free)	10000/Tape & Reel

†For information on tape and reel specifications, including part orientation and tape sizes, please refer to our Tape and Reel Packaging Specification Brochure, BRD8011/D.

NTJD3158C

ELECTRICAL CHARACTERISTICS (T_J = 25°C unless otherwise noted)

Parameter	Symbol	N/P	Test Condition	Min	Typ	Max	Unit
OFF CHARACTERISTICS (Note 3)							
Drain-to-Source Breakdown Voltage	V _{(BR)DSS}	N	V _{GS} = 0 V	I _D = 250 μA	20		V
		P		I _D = -250 μA	-20		
Drain-to-Source Breakdown Voltage Temperature Coefficient	V _{(BR)DSS} /T _J				22		mV/°C
Zero Gate Voltage Drain Current	I _{DSS}	N	V _{GS} = 0 V, V _{DS} = 16 V			1.0	μA
		P	V _{GS} = 0 V, V _{DS} = -16 V			1.0	
Gate-to-Source Leakage Current	I _{GSS}	N	V _{DS} = 0 V, V _{GS} = ±12 V			±10	μA
		P	V _{DS} = 0 V, V _{GS} = ±4.5 V			±1.0	
		P	V _{DS} = 0 V, V _{GS} = ±12 V		6.0		

ON CHARACTERISTICS (Note 2)

Gate Threshold Voltage	V _{GS(TH)}	N	I _D = 250 μA	0.6		1.5	V
		P	I _D = -250 μA	-0.45			
Drain-to-Source On Resistance	R _{DS(on)}	N	V _{GS} = 4.5 V, I _D = 0.63 A		290	375	mΩ
		P	V _{GS} = -4.5 V, I _D = -0.88 A		255	300	
		N	V _{GS} = 2.5 V, I _D = 0.40 A		360	445	
		P	V _{GS} = -2.5 V, I _D = -0.71 A		345	500	
Forward Transconductance	g _{FS}	N	V _{DS} = 4.0 V, I _D = 0.63 A		2.0		S
		P	V _{DS} = -10 V, I _D = -0.88 A		3.0		

CHARGES, CAPACITANCES AND GATE RESISTANCE

Input Capacitance	C _{ISS}	N	f = 1 MHz, V _{GS} = 0 V	V _{DS} = 20 V		33	46	pF	
		P		V _{DS} = -20 V		155			
Output Capacitance	C _{OSS}	N		V _{DS} = 20 V		13	22		
		P		V _{DS} = -20 V		25			
Reverse Transfer Capacitance	C _{RSS}	N		V _{DS} = 20 V		2.8	5.0		
		P		V _{DS} = -20 V		18			
Total Gate Charge	Q _{G(TOT)}	N		V _{GS} = 4.5 V, V _{DS} = 10 V, I _D = 0.63 A		1.3	3.0		nC
		P		V _{GS} = -4.5 V, V _{DS} = -15 V, I _D = -0.88 A		2.2			
Gate-to-Source Charge	Q _{GS}	N		V _{GS} = 4.5 V, V _{DS} = 10 V, I _D = 0.63 A		0.2			
		P		V _{GS} = -4.5 V, V _{DS} = -15 V, I _D = -0.88 A		0.5			
Gate-to-Drain Charge	Q _{GD}	N	V _{GS} = 4.5 V, V _{DS} = 10 V, I _D = 0.63 A		0.4				
		P	V _{GS} = -4.5 V, V _{DS} = -10 V, I _D = -0.88 A		0.65				

SWITCHING CHARACTERISTICS (Note 3)

Turn-On Delay Time	t _{d(ON)}	N	V _{GS} = 4.5 V, V _{DD} = 10 V, I _D = 0.5 A, R _G = 20 Ω		83		ns	
Rise Time	t _r				227			
Turn-Off Delay Time	t _{d(OFF)}				786			
Fall Time	t _f				506			
Turn-On Delay Time	t _{d(ON)}	P		V _{GS} = -4.5 V, V _{DD} = -10 V, I _D = -0.5 A, R _G = 20 Ω		5.8		
Rise Time	t _r					6.5		
Turn-Off Delay Time	t _{d(OFF)}					13.5		
Fall Time	t _f					3.5		

DRAIN-SOURCE DIODE CHARACTERISTICS

Forward Diode Voltage	V _{SD}	N	V _{GS} = 0 V, T _J = 25°C	I _S = 0.23 A	0.76	1.1	V
		P		I _S = -0.48 A	-0.8	-1.2	
		N	V _{GS} = 0 V, T _J = 125°C	I _S = 0.23 A	0.63		
		P		I _S = -0.48 A	-0.66		

2. Pulse Test: pulse width ≤ 300 μs, duty cycle ≤ 2%.

3. Switching characteristics are independent of operating junction temperatures.

NTJD3158C

TYPICAL PERFORMANCE CURVES (N-Ch) ($T_J = 25^\circ\text{C}$ unless otherwise noted)

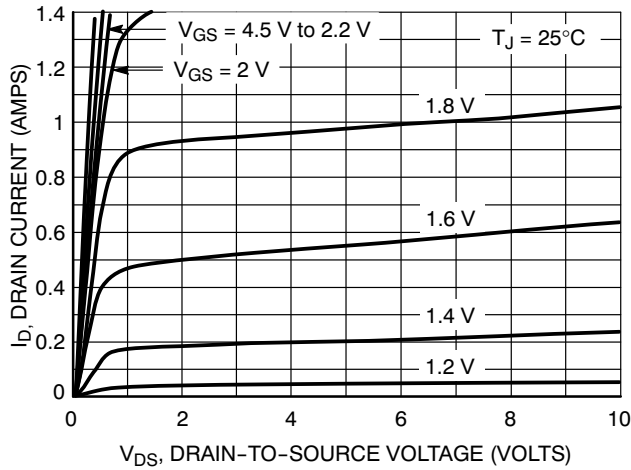

Figure 1. On-Region Characteristics

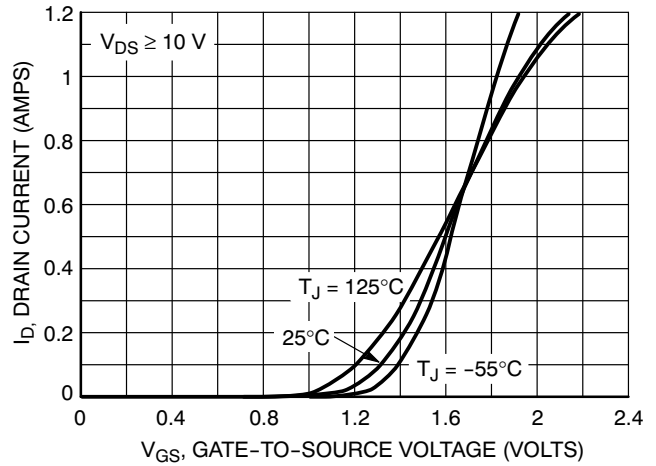

Figure 2. Transfer Characteristics

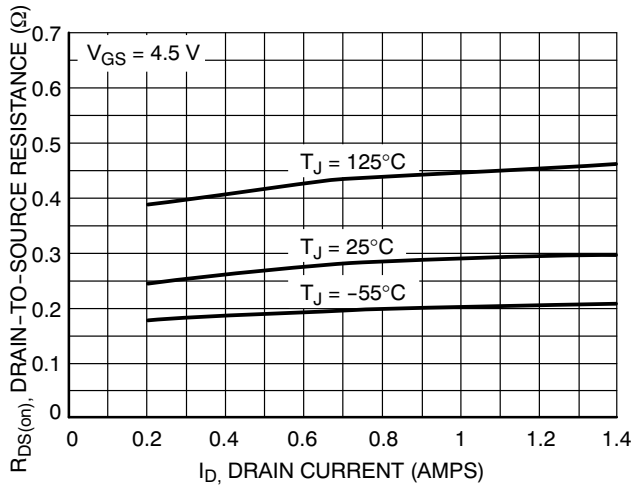

Figure 3. On-Resistance vs. Drain Current and Temperature

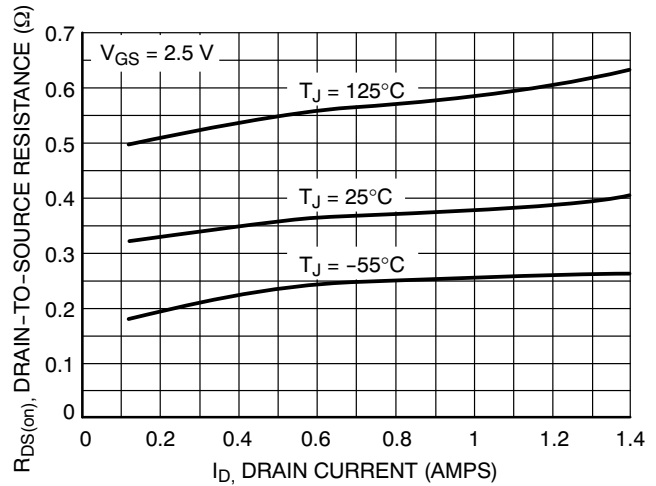

Figure 4. On-Resistance vs. Drain Current and Temperature

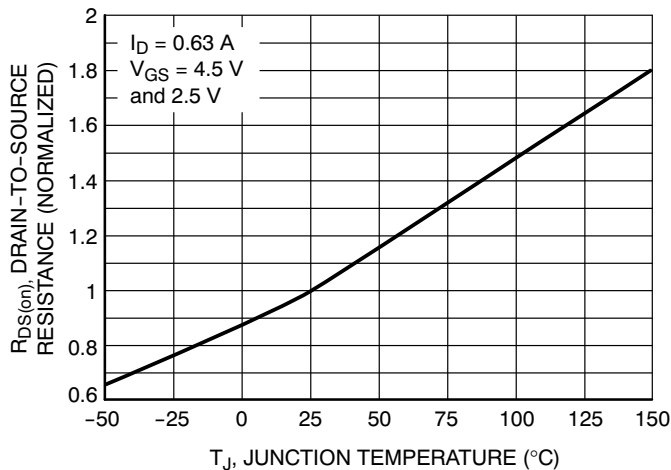

Figure 5. On-Resistance Variation with Temperature

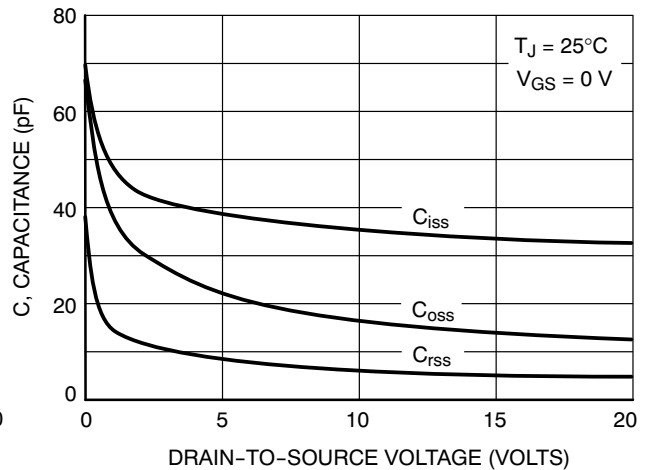

Figure 6. Capacitance Variation

NTJD3158C

TYPICAL PERFORMANCE CURVES (N-Ch) ($T_J = 25^\circ\text{C}$ unless otherwise noted)

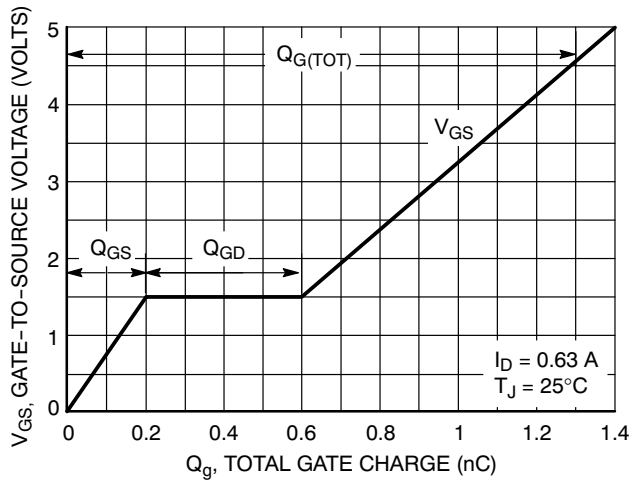

Figure 7. Gate-to-Source and Drain-to-Source Voltage vs. Total Charge

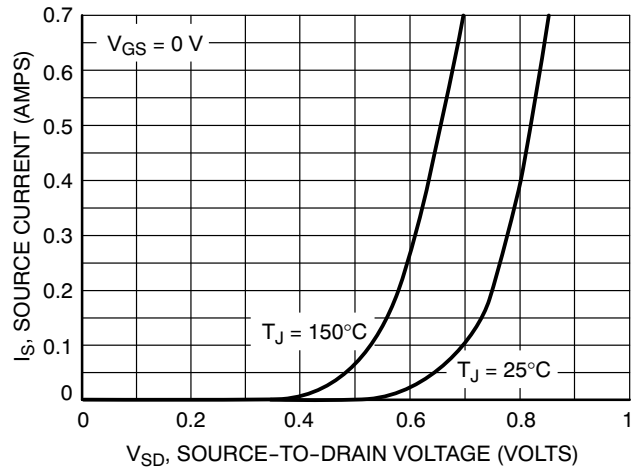

Figure 8. Diode Forward Voltage vs. Current

TYPICAL PERFORMANCE CURVES (P-Ch) ($T_J = 25^\circ\text{C}$ unless otherwise noted)

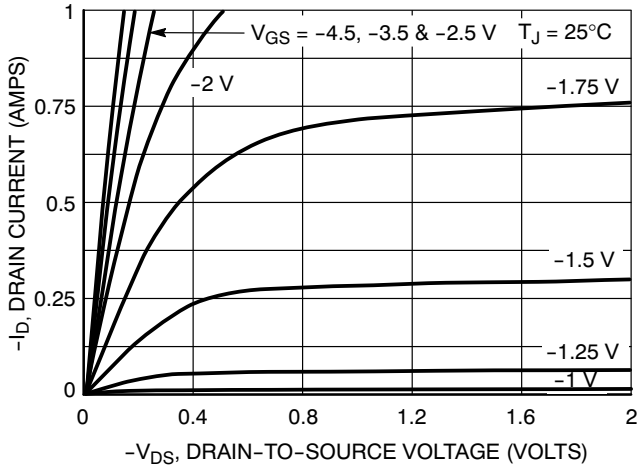

Figure 9. On-Region Characteristics

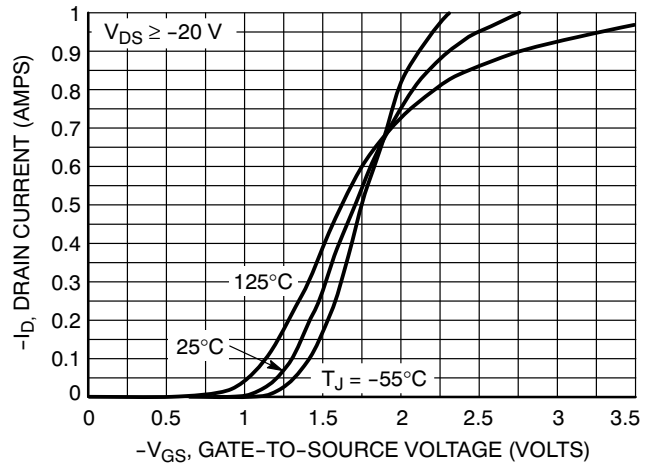

Figure 10. Transfer Characteristics

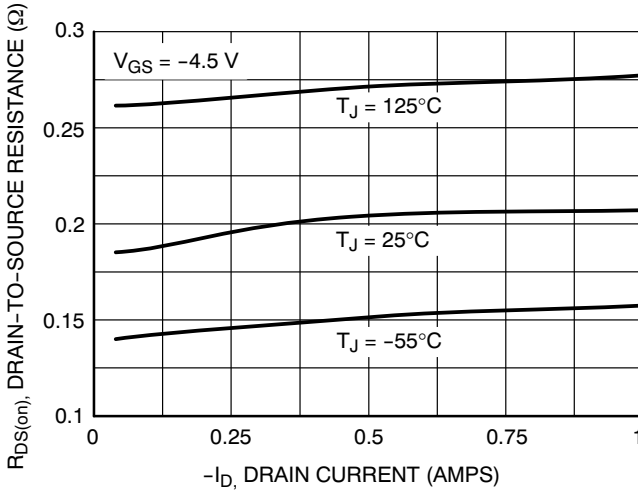

Figure 11. On-Resistance vs. Drain Current and Temperature

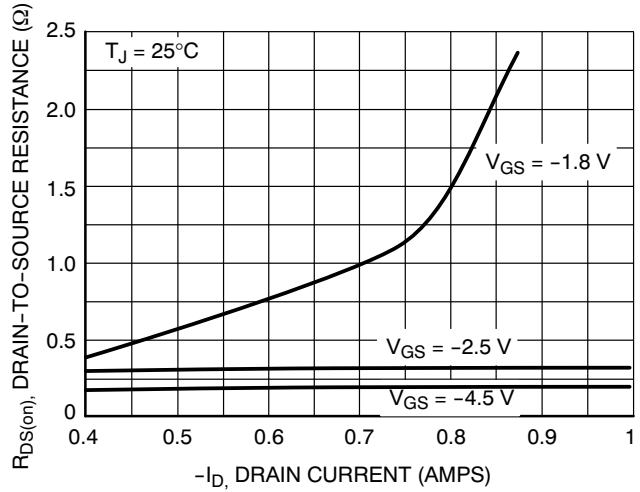

Figure 12. On-Resistance vs. Drain Current and Gate Voltage

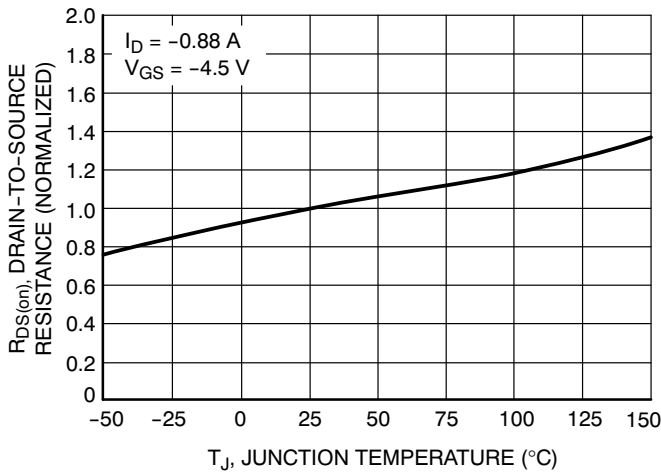

Figure 13. On-Resistance Variation with Temperature

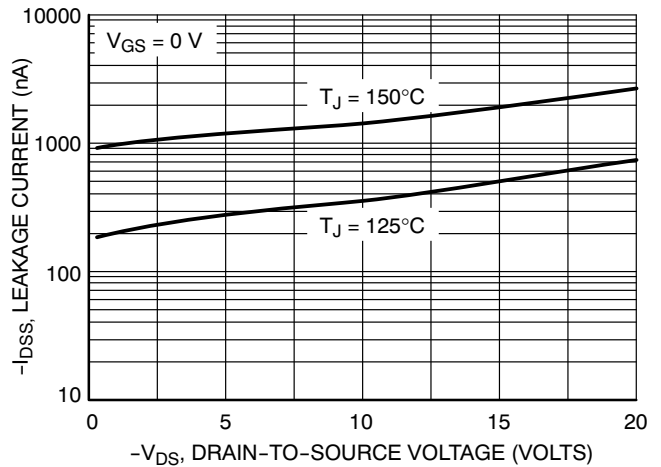

Figure 14. Drain-to-Source Leakage Current vs. Voltage

TYPICAL PERFORMANCE CURVES (P-Ch) ($T_J = 25^\circ\text{C}$ unless otherwise noted)

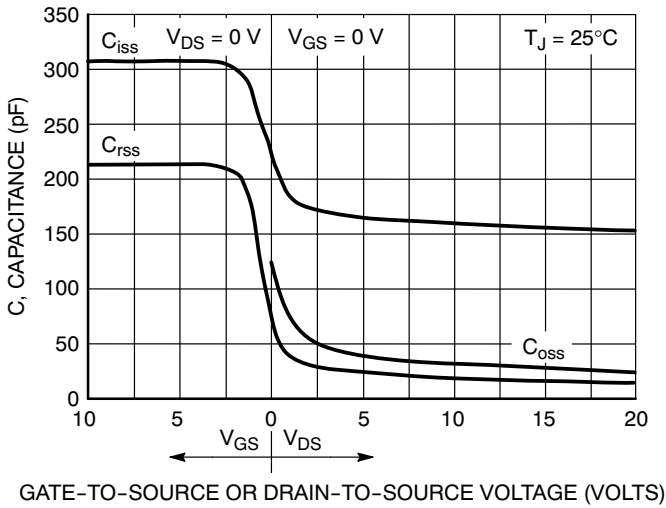

Figure 15. Capacitance Variation

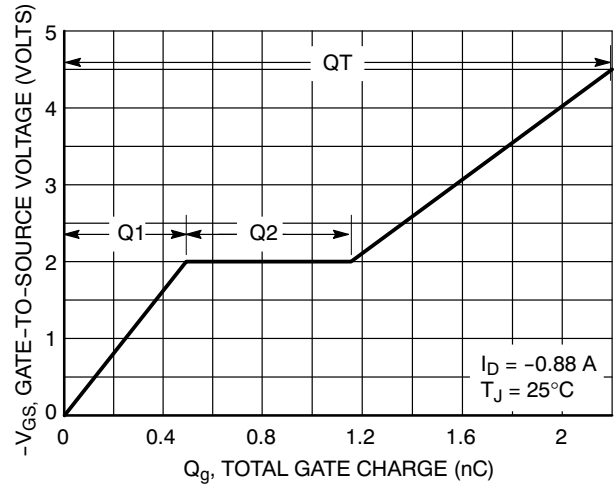

Figure 16. Gate-to-Source Voltage vs. Total Gate Charge

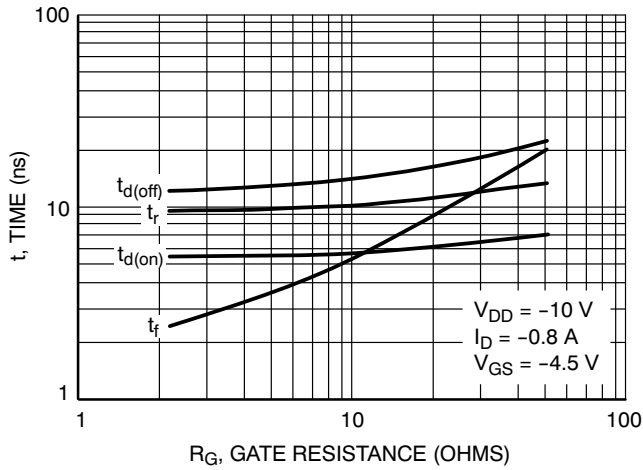

Figure 17. Resistive Switching Time Variation vs. Gate Resistance

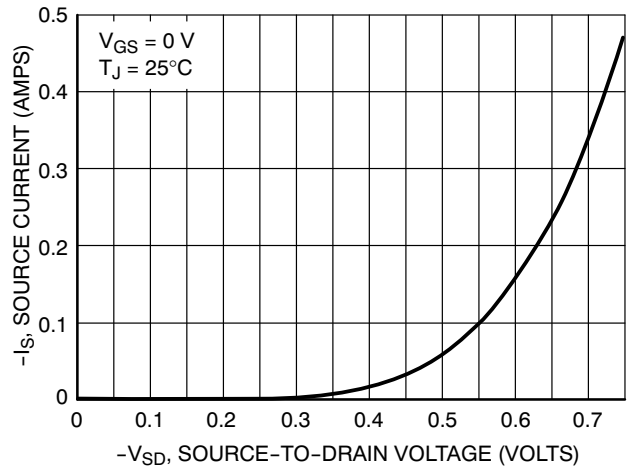
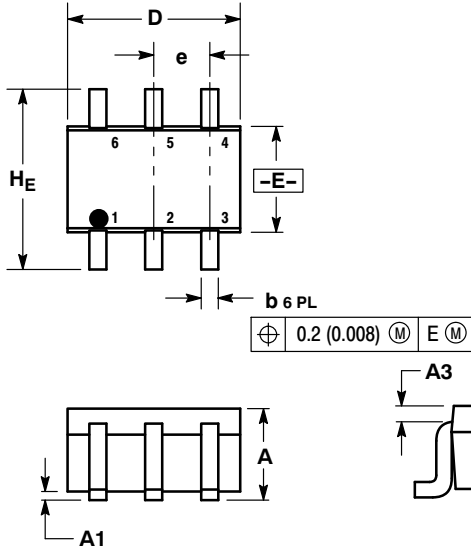

Figure 18. Diode Forward Voltage vs. Current

NTJD3158C

PACKAGE DIMENSIONS

SC-88/SC70-6/SOT-363
CASE 419B-02
ISSUE W



- NOTES:
1. DIMENSIONING AND TOLERANCING PER ANSI Y14.5M, 1982.
 2. CONTROLLING DIMENSION: INCH.
 3. 419B-01 OBSOLETE, NEW STANDARD 419B-02.

DIM	MILLIMETERS			INCHES		
	MIN	NOM	MAX	MIN	NOM	MAX
A	0.80	0.95	1.10	0.031	0.037	0.043
A1	0.00	0.05	0.10	0.000	0.002	0.004
A3	0.20 REF			0.008 REF		
b	0.10	0.21	0.30	0.004	0.008	0.012
C	0.10	0.14	0.25	0.004	0.005	0.010
D	1.80	2.00	2.20	0.070	0.078	0.086
E	1.15	1.25	1.35	0.045	0.049	0.053
e	0.65 BSC			0.026 BSC		
L	0.10	0.20	0.30	0.004	0.008	0.012
HE	2.00	2.10	2.20	0.078	0.082	0.086

- STYLE 26:
PIN 1. SOURCE 1
2. GATE 1
3. DRAIN 2
4. SOURCE 2
5. GATE 2
6. DRAIN 1

SOLDERING FOOTPRINT*

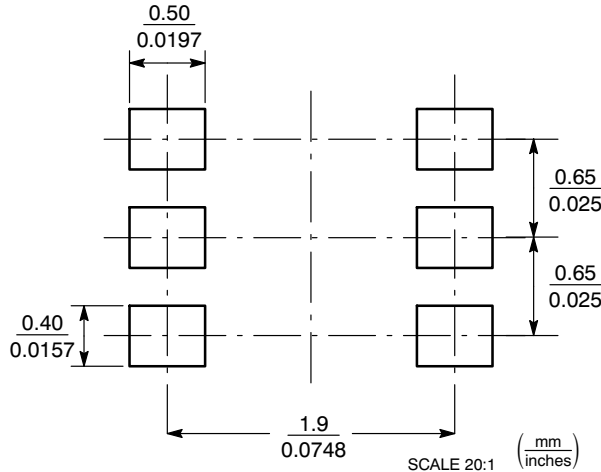

*For additional information on our Pb-Free strategy and soldering details, please download the ON Semiconductor Soldering and Mounting Techniques Reference Manual, SOLDERRM/D.

ON Semiconductor and are registered trademarks of Semiconductor Components Industries, LLC (SCILLC). SCILLC reserves the right to make changes without further notice to any products herein. SCILLC makes no warranty, representation or guarantee regarding the suitability of its products for any particular purpose, nor does SCILLC assume any liability arising out of the application or use of any product or circuit, and specifically disclaims any and all liability, including without limitation special, consequential or incidental damages. "Typical" parameters which may be provided in SCILLC data sheets and/or specifications can and do vary in different applications and actual performance may vary over time. All operating parameters, including "Typicals" must be validated for each customer application by customer's technical experts. SCILLC does not convey any license under its patent rights nor the rights of others. SCILLC products are not designed, intended, or authorized for use as components in systems intended for surgical implant into the body, or other applications intended to support or sustain life, or for any other application in which the failure of the SCILLC product could create a situation where personal injury or death may occur. Should Buyer purchase or use SCILLC products for any such unintended or unauthorized application, Buyer shall indemnify and hold SCILLC and its officers, employees, subsidiaries, affiliates, and distributors harmless against all claims, costs, damages, and expenses, and reasonable attorney fees arising out of, directly or indirectly, any claim of personal injury or death associated with such unintended or unauthorized use, even if such claim alleges that SCILLC was negligent regarding the design or manufacture of the part. SCILLC is an Equal Opportunity/Affirmative Action Employer. This literature is subject to all applicable copyright laws and is not for resale in any manner.

PUBLICATION ORDERING INFORMATION

LITERATURE FULFILLMENT:
Literature Distribution Center for ON Semiconductor
P.O. Box 5163, Denver, Colorado 80217 USA
Phone: 303-675-2175 or 800-344-3860 Toll Free USA/Canada
Fax: 303-675-2176 or 800-344-3867 Toll Free USA/Canada
Email: orderlit@onsemi.com

N. American Technical Support: 800-282-9855 Toll Free
USA/Canada
Europe, Middle East and Africa Technical Support:
Phone: 421 33 790 2910
Japan Customer Focus Center
Phone: 81-3-5773-3850

ON Semiconductor Website: www.onsemi.com

Order Literature: <http://www.onsemi.com/orderlit>

For additional information, please contact your local Sales Representative